

CATÁLOGO DE PRODUTOS

MULTI ***Light***®

PLÁSTICOS E AUTOPEÇAS

TECNOLOGIA EM SINALIZAÇÃO AUTOMOTIVA

WWW.MULTILIGHTSINALEIRAS.COM.BR



CÓD. MULTILIGHT	DESCRIÇÃO / APLICAÇÃO	DIM. (mm)	LARG.	ALT.	PROF.
1243	Lanterna lateral Marcopolo, Busscar, Volks. Nº Orig.: Marcopolo AM: 022012021, VM: 102012013. Busscar: AM: 1.1374214, VM: 1.1374222. Volks: AM: T009491	105	46	29	



CÓD. MULTILIGHT	DESCRIÇÃO / APLICAÇÃO	DIM. (mm)	LARG.	ALT.	PROF.
1243/1	Lanterna lateral com base reta Caio, Comil. Nº Orig.: Comil AM: 40116403191. Caio AM: 042006239	105	46	29	



CÓD. MULTILIGHT	DESCRIÇÃO / APLICAÇÃO	DIM. (mm)	LARG.	ALT.	PROF.
1255	Lanterna Brake Light Busscar com lâmpada torpedeo. Nº Orig.: 1.374295	300	28	42	

1255/L

Lente



CÓD. MULTILIGHT	DESCRIÇÃO / APLICAÇÃO	DIM. (mm)	LARG.	ALT.	PROF.
1255/2	Lanterna Brake Light Caio e Comil c/ lâmpada torpedeo. Nº Orig.: Caio 042006239. Comil 40116403191	300	28	42	

1255/2-L

Lente

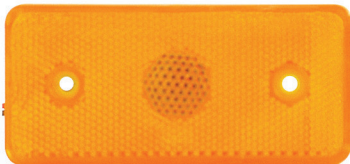

CÓD. MULTILIGHT	DESCRIÇÃO / APLICAÇÃO	DIM. (mm)	LARG.	ALT.	PROF.
1257	Lanterna lateral posição e retrorrefletor Caio, Marcopolo, Busscar, Volvo e Comil. Nº Orig.: Caio AM: 42006193. Volvo AM: 8121815	123	60	53	

1257/S

Sem soquete

1257/1

Retrorrefletor Lateral Caio, Marcopolo

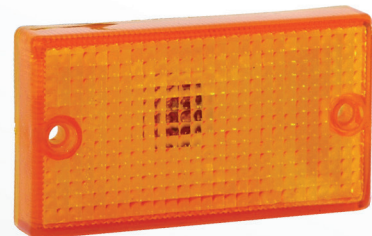

CÓD. MULTILIGHT	DESCRIÇÃO / APLICAÇÃO	DIM. (mm)	LARG.	ALT.	PROF.
1262	Lanterna delimitadora superior modelo Busscar. Nº Orig.: AM: 1.374.559, VM: 1.374.540, CR: 1.374.550	100	26	56	



CÓD. MULTILIGHT	DESCRIÇÃO / APLICAÇÃO	DIM. (mm)	LARG.	ALT.	PROF.
1262/1	Lanterna delimitadora superior modelo Busscar com lente abaulada	100	30	56	

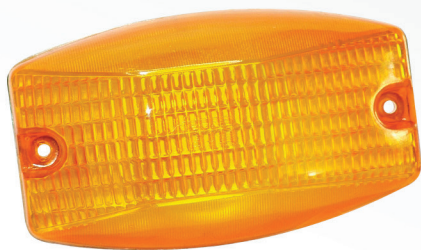

CÓD. MULTILIGHT	DESCRIÇÃO / APLICAÇÃO	DIM. (mm)	LARG.	ALT.	PROF.
1263	Lanterna lateral Marcopolo Torino G IV, GV. Nº Orig.: AM: 27202116-6		120	70	61

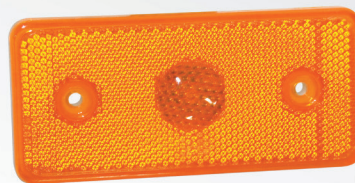

CÓD. MULTILIGHT	DESCRIÇÃO / APLICAÇÃO	DIM. (mm)	LARG.	ALT.	PROF.
2011-12V	Lanterna lateral led posição e retrorefletor 12V		123	60	16
2011-24V	Lanterna lateral led posição e retrorefletor 24V				



CÓD. MULTILIGHT	DESCRIÇÃO / APLICAÇÃO	DIM. (mm)	PROF.	Ø
1265	Lanterna delimitadora superior Marcopolo, Busscar e Caio. Nº Orig.: Marcopolo AM: 26200717-1. VM: 26200681-7. CR: 26200675-7		55	70



CÓD. MULTILIGHT	DESCRIÇÃO / APLICAÇÃO	DIM. (mm)	PROF.	Ø
1266	Lanterna traseira Ø 155mm c/ parafuso na base. Busscar, Caio, Marcopolo. Nº Orig.: Busscar AM: 1.381.377. VM: 1.381.369. CR: 1.381.350		83	155



CÓD. MULTILIGHT	DESCRIÇÃO / APLICAÇÃO	DIM. (mm)	PROF.	Ø
1266/1	Lanterna traseira Ø 155mm com parafuso na base. Busscar, Caio, Marcopolo. Nº Orig.: Busscar AM: 1.381.377. VM: 1.381.369. CR: 1.381.350		83	155



CÓD. MULTILIGHT	DESCRIÇÃO / APLICAÇÃO	DIM. (mm)	LARG.	ALT.	PROF.
1267	Lanterna traseira/dianteira Marcopolo Torino 1999 - 2006, Alegre e Senior. Nº Orig.: AM: 26200672-8. VM: 26200673-4. CR: 26200674-0		179	100	95



CÓD. MULTILIGHT	DESCRIÇÃO / APLICAÇÃO	DIM. (mm)	LARG.	ALT.	PROF.
1267/1	Lanterna traseira/dianteira Marcopolo Torino 1999 - 2006, Alegre e Volare, com lente lisa, metalizada		179	100	95



CÓD. MULTILIGHT	DESCRIÇÃO / APLICAÇÃO	DIM. (mm)	LARG.	ALT.	PROF.
1268	Lanterna lateral posição e retrorefletor mod. Marcopolo e Caio. Nº Orig.: Marcopolo AM: 992004052. Caio AM: 92210003002		112	52	58



CÓD. MULTILIGHT	DESCRIÇÃO / APLICAÇÃO	DIM. (mm)	LARG.	ALT.	PROF.
2003 - 12V	Lanterna lateral led posição e retrorrefletor 12V		112	52	57
2003 - 24V	Lanterna lateral led posição e retrorrefletor 24V				



CÓD. MULTILIGHT	DESCRIÇÃO / APLICAÇÃO	DIM. (mm)	LARG.	ALT.	PROF.
1269/1	Lanterna traseira Ø 125mm com parafuso na base e lente diamantada			75	125



CÓD. MULTILIGHT	DESCRIÇÃO / APLICAÇÃO	DIM. (mm)	PROF.	Ø
1269/2	Lanterna traseira Ø 125mm Neobus 2003-2006. Nº Orig.: AM: 22060006, VM: 22060005, CR: 22060010. VM/CR: 2206007	75	125	



CÓD. MULTILIGHT	DESCRIÇÃO / APLICAÇÃO	DIM. (mm)	PROF.	Ø
1269/4	Lanterna traseira Ø 125mm Neobus 2007 em diante	75	125	



CÓD. MULTILIGHT	DESCRIÇÃO / APLICAÇÃO	DIM. (mm)	LARG.	ALT.	PROF.
1271	Lanterna lateral posição e retrorrefletor mod. Marcopolo, Busscar e Caio	122	76	50	



CÓD. MULTILIGHT	DESCRIÇÃO / APLICAÇÃO	DIM. (mm)	LARG.	ALT.	PROF.
1285	Lanterna delimitadora superior/lateral Marcopolo G VI. Nº Orig.: AM: 17201007-9. VM: 17201005-6. CR: 17201007-5. VD: 17201006-2	105	81	48	

LINHA ÔNIBUS



CÓD. MULTILIGHT	DESCRIÇÃO / APLICAÇÃO	DIM. (mm)	LARG.	ALT.	PROF.
1285/1	Lanterna delimitadora superior/lateral Marcopolo G VI série II. N° Orig.: AM: 15200422-0. VM: 15200424-3, CR: 15200423-7. VD: 1520042104	105	82	65	
1285/1-L	Lente				



CÓD. MULTILIGHT	DESCRIÇÃO / APLICAÇÃO	DIM. (mm)	LARG.	ALT.	PROF.
1286/3-12V	Lanterna Lateral posição e retrorefletor Marcopolo G VI, Caio, Neobus. Posição/direcional com lampled 12V	142	68	90	
1286/3-24V	Lanterna Lateral posição e retrorefletor Marcopolo G VI, Caio, Neobus. Posição/direcional com lampled 24V				



CÓD. MULTILIGHT	DESCRIÇÃO / APLICAÇÃO	DIM. (mm)	LARG.	ALT.	PROF.
1287	Lanterna lateral posição Marcopolo Volare, direcional Marruá, direcional Troller. N° Orig.: Marcopolo AM: 3320008-8. Troller AM: 0102.856	110	45	47	



CÓD. MULTILIGHT	DESCRIÇÃO / APLICAÇÃO	DIM. (mm)	LARG.	ALT.	PROF.
1288/1-12V	Lanterna Brake Light 18 leds Neobus. 12V. N° Orig.: 18060003	230	40	32	
1288/1-24V	Lanterna Brake Light 18 leds Neobus. 24V. N° Orig.: 21060003				



CÓD. MULTILIGHT	DESCRIÇÃO / APLICAÇÃO	DIM. (mm)	LARG.	ALT.	PROF.
1286	Lanterna Lateral posição e retrorefletor Marcopolo G VI, Caio e Neobus	142	68	90	
1286/1	Lanterna Lateral direcional e retrorefletor Marcopolo G VI, Caio, Neobus. N° Orig.: Marcopolo AM sem pisca: 172012084				
1286/2	Lanterna Lateral posição e retrorefletor Marcopolo G VI, Caio, Neobus. N° Orig.: Marcopolo AM pos./direcional: 99200730, 1220008-7				



CÓD. MULTILIGHT	DESCRIÇÃO / APLICAÇÃO	DIM. (mm)	LARG.	ALT.	PROF.
1286/4-12V	Lanterna Lateral posição e retrorefletor Marcopolo G VI, Caio, Neobus. Direcional com lampled 12V	142	68	90	
1286/4-24V	Lanterna Lateral posição e retrorefletor Marcopolo G VI, Caio, Neobus. Direcional com lampled 24V				



CÓD. MULTILIGHT	DESCRIÇÃO / APLICAÇÃO	DIM. (mm)	LARG.	ALT.	PROF.
1288-12V	Lanterna Brake Light 36 leds Marcopolo Torino 1999 em diante 12V. N° Orig.: 262006800	230	40	32	
1288-24V	Lanterna Brake Light 36 leds Marcopolo Torino 1999 em diante 24V. N° Orig.: 262006800				



LED



CÓD. MULTILIGHT	DESCRIÇÃO / APLICAÇÃO	DIM. (mm)	LARG.	ALT.	PROF.
1289-12V	Lanterna Brake light 48 leds 12V modelo Caio, Neobus, Busscar, Comil, Volks Saveiro Gil/ GIII. Nº Orig.: Neobus: 19200001	286	26	25	
1289-24V	Lanterna Brake light 48 leds 24V modelo Caio, Neobus, Busscar, Comil. Nº Orig.: Neobus: 19200001				



LED



CÓD. MULTILIGHT	DESCRIÇÃO / APLICAÇÃO	DIM. (mm)	LARG.	ALT.	PROF.
1295-12V	Lanterna Brake light 48 leds Marcopolo G VI. 12V		290	46	40
1295-24V	Lanterna Brake light 48 leds Marcopolo G VI. 24V. Nº Orig.: com conector: 99200563-7. sem conector: 172010040				



LED



CÓD. MULTILIGHT	DESCRIÇÃO / APLICAÇÃO	DIM. (mm)	LARG.	ALT.	PROF.
2026-12V	Lanterna Brake Light 6 leds SMD com cabo, mod. Caio, Neobus 12V	288	25	25	
2026-24V	Lanterna Brake Light 6 leds SMD com cabo, mod. Caio, Neobus 24V.				



LED



CÓD. MULTILIGHT	DESCRIÇÃO / APLICAÇÃO	DIM. (mm)	LARG.	ALT.	PROF.
2026/1-12V	Lanterna Brake Light 6 leds SMD para conector, modelo Busscar 12V		288	25	25
2026/1-24V	Lanterna Brake Light 6 leds SMD para conector, modelo Busscar 24V				



CÓD. MULTILIGHT	DESCRIÇÃO / APLICAÇÃO	DIM. (mm)	LARG.	ALT.	PROF.
1292	Lanterna delimitadora superior modelo Busscar com soquete	180	30	64	
1292/1	Lanterna delimitadora superior modelo Busscar sem soquete				



CÓD. MULTILIGHT	DESCRIÇÃO / APLICAÇÃO	DIM. (mm)	PROF.	Ø
1293	Lanterna direcional, posição/ freio Ø 70mm, Caio, Neobus, Busscar, Comil e Mascarello		68	70



CÓD. MULTILIGHT	DESCRIÇÃO / APLICAÇÃO	DIM. (mm)	PROF.	Ø
1293/1	Lanterna direcional, posição/ freio Ø 70mm modelo novo, Caio, Neobus, Comil e Mascarello		68	70



CÓD. MULTILIGHT	DESCRIÇÃO / APLICAÇÃO	DIM. (mm)	LARG.	ALT.	PROF.
1294	Lanterna degrau/placa. Marcopolo, Caio, Comil e Mascarello		76	32	53



CÓD. MULTILIGHT	DESCRIÇÃO / APLICAÇÃO	DIM. (mm)	PROF.	Ø
1320	Lanterna traseira Ø 155mm com parafuso passante, Marcopolo Torino 2007, Ciferal Citimax. Nº Orig.: AM: 26201280-6, VM: 26201292-4, CR: 26201291-8	78	155	



CÓD. MULTILIGHT	DESCRIÇÃO / APLICAÇÃO	DIM. (mm)	PROF.	Ø
1322	Lanterna traseira Ø 125mm Marcopolo Ideale, Ciferal Citimax. Nº Orig.: AM: 272012658, VM: 272012664	75	125	



CÓD. MULTILIGHT	DESCRIÇÃO / APLICAÇÃO	DIM. (mm)	PROF.	Ø
1323	Lanterna traseira/ dianteira Ø 95mm Marcopolo Ideale, Ciferal Citimax. Nº Orig.: AM: 2620.1126-3, VM: 26201126-7, CR: 2620.1128-0	79	95	



CÓD. MULTILIGHT	DESCRIÇÃO / APLICAÇÃO	DIM. (mm)	LARG.	ALT.	PROF.
1324/1-12V	Lanterna led delimitadora superior/lateral Marcopolo GV 12V	79	35	90	
1324/1-24V	Lanterna led delimitadora superior/lateral Marcopolo GV 24V				



CÓD. MULTILIGHT	DESCRIÇÃO / APLICAÇÃO	DIM. (mm)	LARG.	ALT.	PROF.
1321	Lanterna direcional dianteira Marcopolo Torino 2007 em diante, Volare. Nº Orig.: AM: 262011304, CR: 26201126-7		119	70	76

CÓD. MULTILIGHT	DESCRIÇÃO / APLICAÇÃO	DIM. (mm)	PROF.	Ø	
1322/1	Lanterna traseira/dianteira Ø 125mm mod. Caio Mondego, Apache. Nº Orig.: AM: 922110025001, VM: 92210024001, CR: 92210026001		75	125	



CÓD. MULTILIGHT	DESCRIÇÃO / APLICAÇÃO	DIM. (mm)	LARG.	ALT.	PROF.
1324	Lanterna delimitadora superior/lateral Marcopolo GV. Nº Orig.: AM: 10201285-2, VM: 10201284-6, CR: 10201283-0, VD: 10201286-9		79	35	90



CÓD. MULTILIGHT	DESCRIÇÃO / APLICAÇÃO	DIM. (mm)	LARG.	ALT.	PROF.
2024-12V	Lanterna lateral led posição e retrorrefletor, Marcopolo Volare e Caio 12V. Nº Orig.: Marcopolo AM: 10261854		180	30	49
2024-24V	Lanterna lateral led posição e retrorrefletor, Marcopolo Volare e Caio 24V. Nº Orig.: Marcopolo AM: 10261853, VM: 10429516				



CÓD. MULTILIGHT	DESCRIÇÃO / APLICAÇÃO	DIM. (mm)	LARG.	ALT.	PROF.
2025-12V	Lanterna led delimitadora superior modelo Busscar com chicote selado 12V	180	30	49	
2025-24V	Lanterna led delimitadora superior modelo Busscar com chicote selado 24V				



CÓD. MULTILIGHT	DESCRIÇÃO / APLICAÇÃO	DIM. (mm)	LARG.	ALT.	PROF.
2025/1-12V	Lanterna led delimitadora superior modelo Busscar sem chicote selado 12V	180	30	49	
2025/1-24V	Lanterna led delimitadora superior modelo Busscar sem chicote selado 24V				

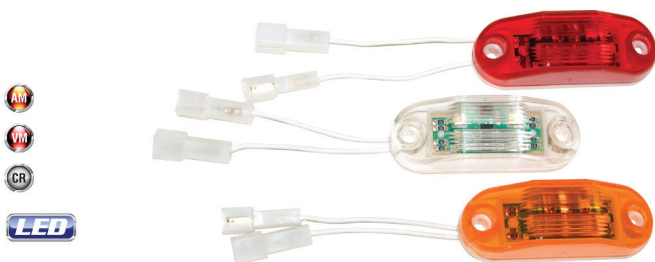

CÓD. MULTILIGHT	DESCRIÇÃO / APLICAÇÃO	DIM. (mm)	LARG.	ALT.	PROF.
2029-12V	Lanterna led delimitadora superior/lateral com cabo 12V Caio e universal	68	24	19	
2029-24V	Lanterna led delimitadora superior/lateral com cabo 24V Caio e universal				



CÓD. MULTILIGHT	DESCRIÇÃO / APLICAÇÃO	DIM. (mm)	LARG.	ALT.	PROF.
2029/1-12V	Lanterna led delimitadora superior/lateral para conector selado 12V Caio e universal	68	24	19	
2029/1-24V	Lanterna led delimitadora superior/lateral para conector selado 24V Caio e universal				



CÓD. MULTILIGHT	DESCRIÇÃO / APLICAÇÃO	DIM. (mm)	PROF.	Ø
2031-12V	Lanterna traseira led Ø 125mm modelo Caio, Marcopolo Ideale 12V	42	125	
2031-24V	Lanterna traseira led Ø 125mm modelo Caio, Marcopolo Ideale 24V			



CÓD. MULTILIGHT	DESCRIÇÃO / APLICAÇÃO	DIM. (mm)	PROF.	Ø
050677	Lanterna traseira led Ø 125mm luz de ré com lente cristal mod. Caio Apache Vip Branca 12V	42	125	
050678	Lanterna traseira led Ø 125mm luz de ré com lente cristal mod. Caio Apache Vip Branca 24V			



CR

LED

CÓD. MULTILIGHT	DESCRIÇÃO / APLICAÇÃO	DIM. (mm)	PROF.	Ø
050688	Lanterna traseira led Ø 125mm direcional com lente cristal mod. Caio Apache Vip Amarela 12V	42	125	
050689	Lanterna traseira led Ø 125mm direcional com lente cristal mod. Caio Apache Vip Amarela 24V			

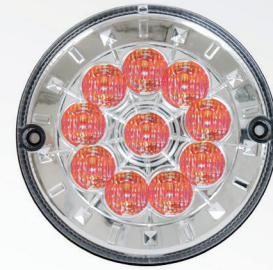

CR

LED

CÓD. MULTILIGHT	DESCRIÇÃO / APLICAÇÃO	DIM. (mm)	PROF.	Ø
050690	Lanterna traseira led Ø 125mm direcional posição/freio com lente cristal mod. Caio Apache Vip Vermelha 12V	42	125	
050691	Lanterna traseira led Ø 125mm direcional posição/freio com lente cristal modelo Caio Apache Vip. Vermelha 24V			

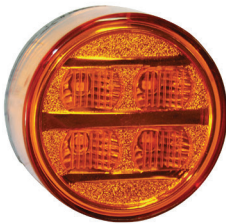

AM

LED

CÓD. MULTILIGHT	DESCRIÇÃO / APLICAÇÃO	DIM. (mm)	PROF.	Ø
2032	Lanteran led dianteira/traseira direcional Ø 70mm mod. Caio, Neobus, Comil e Mascarello. Bivolt	57	70	



CR

LED

CÓD. MULTILIGHT	DESCRIÇÃO / APLICAÇÃO	DIM. (mm)	PROF.	Ø
2032/1	Lanteran led dianteira/traseira luz de ré/daytime running light Ø 70mm mod. Caio, Neobus, Comil e Mascarello. Bivolt	57	70	



CR

LED

CÓD. MULTILIGHT	DESCRIÇÃO / APLICAÇÃO	DIM. (mm)	PROF.	Ø
2032/2	Lanteran led dianteira/traseira direcional com lente cristal Ø 70mm modelo Caio, Neobus, Comil e Mascarello. Bivolt	57	70	



VR

LED

CÓD. MULTILIGHT	DESCRIÇÃO / APLICAÇÃO	DIM. (mm)	PROF.	Ø
050161	Lanterna traseira led posição/freio Ø 155mm mod. Marcopolo Torino e Ciferal Citimax 12V	51	155	
050164	Lanterna traseira led posição/freio Ø 155mm mod. Marcopolo Torino e Ciferal Citimax 24V			

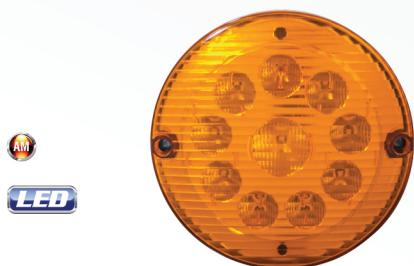

CÓD. MULTILIGHT	DESCRIÇÃO / APLICAÇÃO	DIM. (mm)	PROF.	Ø
050162	Lanterna traseira led direcional Ø 155mm mod. Marcopolo Torino e Ciferal Citimax 12V	155	51	155
050165	Lanterna traseira led direcional Ø 155mm mod. Marcopolo Torino e Ciferal Citimax 24V	155	51	155

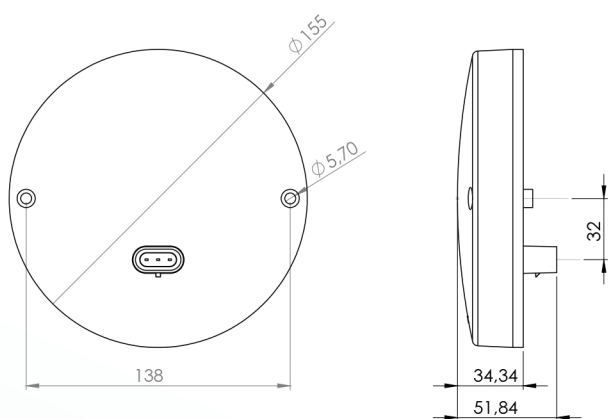

CÓD. MULTILIGHT	DESCRIÇÃO / APLICAÇÃO	DIM. (mm)	PROF.	Ø
050163	Lanterna traseira led luz de ré Ø 155mm mod. Marcopolo Torino e Ciferal Citimax. 12V	155	51	155
050166	Lanterna traseira luz de ré Ø 155mm modelo Marcopolo Torino, Ciferal Citimax. 24V	155	51	155



CÓD. MULTILIGHT	DESCRIÇÃO / APLICAÇÃO	DIM. (mm)	LARG.	ALT.	PROF.
050707	PCI 6 leds para teto urbano 600x30mm 24V	600	30	30	
050708	PCI 6 leds para teto urbano 600x30mm 12V	600	30	30	



CÓD. MULTILIGHT	DESCRIÇÃO / APLICAÇÃO	DIM. (mm)	PROF.	Ø
050706	Lanterna led iluminação porta Ø 74mm cristal mod. Caio 24V	74	20	74
050707	Lanterna led iluminação porta Ø 74mm cristal mod. Caio 12V	74	20	74



CÓD. MULTILIGHT	DESCRIÇÃO / APLICAÇÃO	DIM. (mm)	LARG.	ALT.	PROF.
050734	Lanterna lateral led posição/retrorefletor Marcopolo G7, Torino, Ideale, Viale e Senior. Amarela 12V.	132	40	31	
050735	Lanterna lateral led posição/retrorefletor Marcopolo G7, Torino, Ideale, Viale e Senior Amarela 24V. Nº Orig.: 10008544	132	40	31	



LED



CÓD. MULTILIGHT	DESCRIÇÃO / APLICAÇÃO	DIM. (mm)	LARG.	ALT.	PROF.
050736	Lanterna lateral led posição/retrorefletor Marcopolo G7, Torino, Ideale, Viale e Senior. Vermelha 12V.		132	40	31
050737	Lanterna lateral led posição/retrorefletor Marcopolo G7, Torino, Ideale, Viale e Senior. Vermelha 24V. Nº Orig.: 10168377				



LED



CÓD. MULTILIGHT	DESCRIÇÃO / APLICAÇÃO	DIM. (mm)	PROF.	Ø
050748	Lanterna delimitadora led Ø 70mm Caio, Marcopolo amarela 12V		12	70
050749	Lanterna delimitadora led Ø 70mm Caio, Marcopolo amarela 24V			



CÓD. MULTILIGHT	DESCRIÇÃO / APLICAÇÃO	DIM. (mm)	LARG.	ALT.	PROF.
040510	Luminária interna tipo perfil 6 leds 30 x 300mm Bivolt. Aplicação em furgões, câmeras frigoríficas, baús e universal		340	50	28

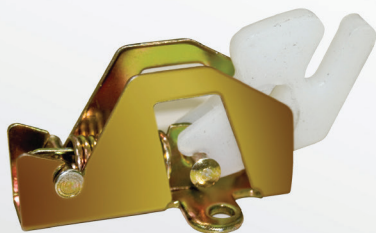

CÓD. MULTILIGHT	DESCRIÇÃO / APLICAÇÃO	DIM. (mm)	LARG.	ALT.	PROF.
1600	Trinco gatilho (bico de papagaio) de portinhola, Busscar, Neobus e Marcopolo. Nº Orig.: Busscar: 1301144. Neobus: 21140015. Marcopolo: 110143154.		132	40	31



LED

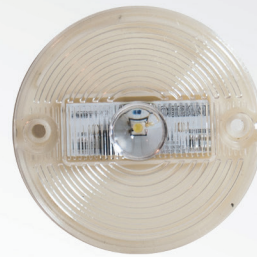

CÓD. MULTILIGHT	DESCRIÇÃO / APLICAÇÃO	DIM. (mm)	PROF.	Ø
050746	Lanterna delimitadora led Ø 70mm Caio, Marcopolo cristal 12V		12	70
050747	Lanterna delimitadora led Ø 70mm Caio, Marcopolo cristal 24V			



LED

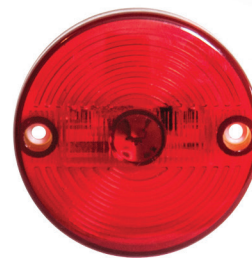

CÓD. MULTILIGHT	DESCRIÇÃO / APLICAÇÃO	DIM. (mm)	PROF.	Ø
050750	Lanterna delimitadora led Ø 70mm Caio, Marcopolo vermelha 12V		12	70
050751	Lanterna delimitadora led Ø 70mm Caio, Marcopolo vermelha 24V			



CÓD. MULTILIGHT	DESCRIÇÃO / APLICAÇÃO	DIM. (mm)	LARG.	ALT.	PROF.
1398	Conjunto Porta-Foco 2 luz, 2 ar, Marcopolo GV, GVI				



CÓD. MULTILIGHT	DESCRIÇÃO / APLICAÇÃO	DIM. (mm)	LARG.	ALT.	PROF.
4409	Capa lanterna degrau Caio, Marcopolo, Comil, Busscar e Neobus.		132	40	31